

Sheet: /nano/  
File: nano.sch

**Title:**

Size: A4  
KiCad E.D.A. kicad 5.0.0

Date:

Rev:  
Id: 2/7

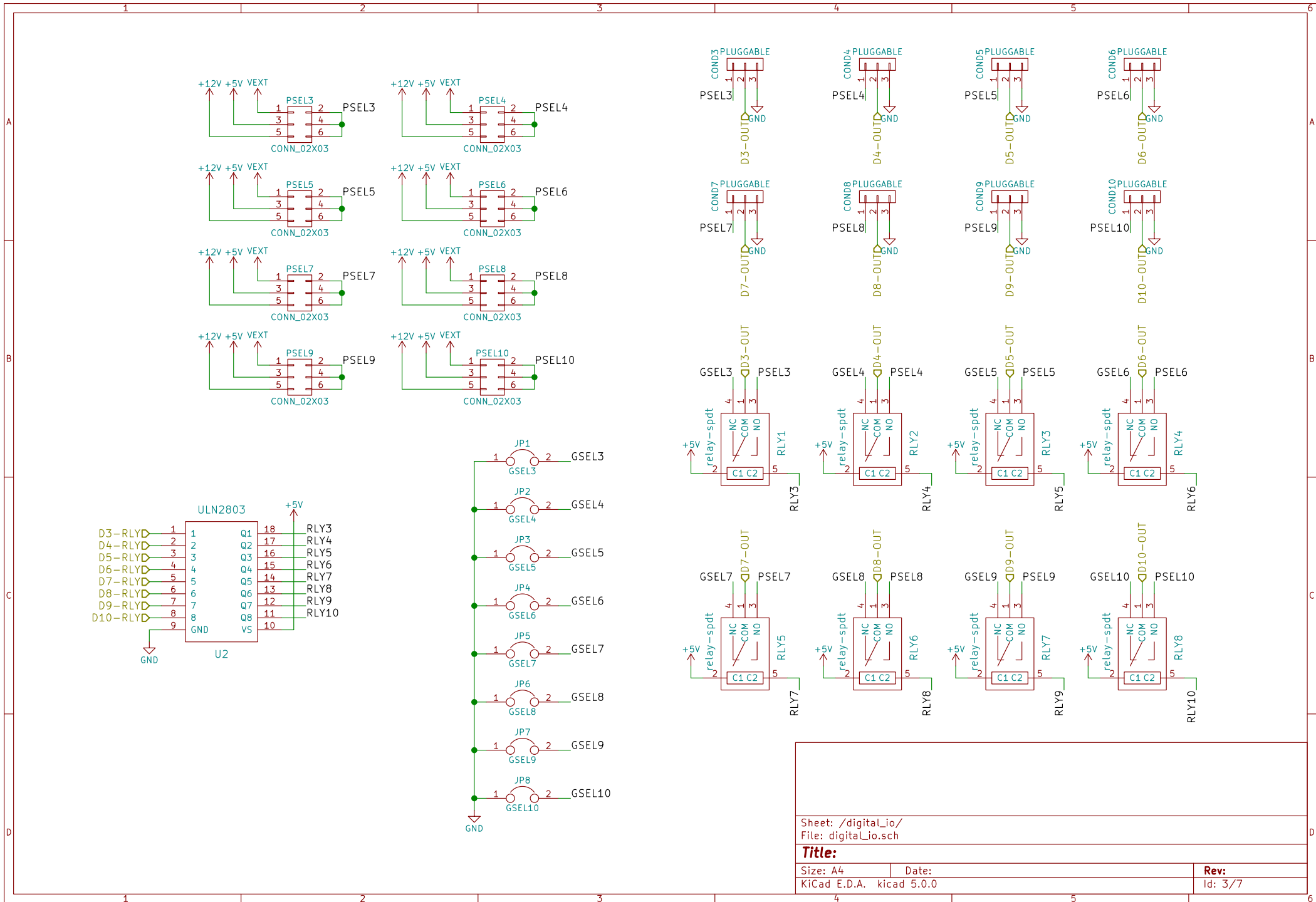

Sheet: /digital\_io/  
 File: digital\_io.sch

**Title:**

Size: A4  
 KiCad E.D.A. kicad 5.0.0

Date:

**Rev:**  
 Id: 3/7

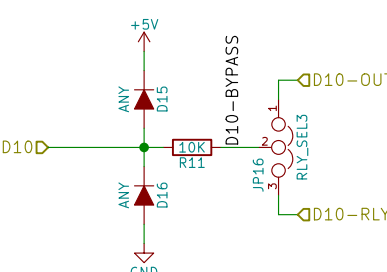
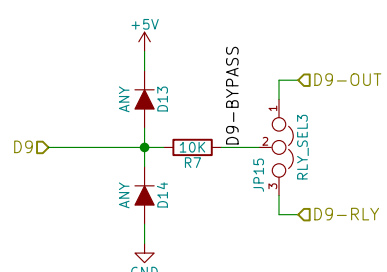
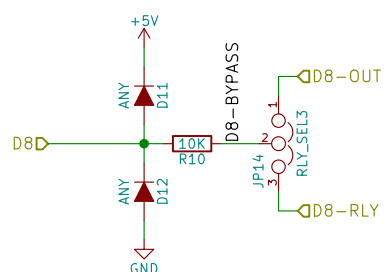
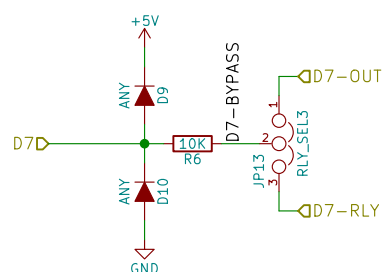
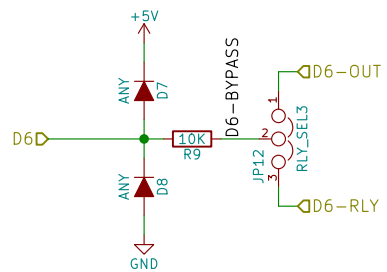
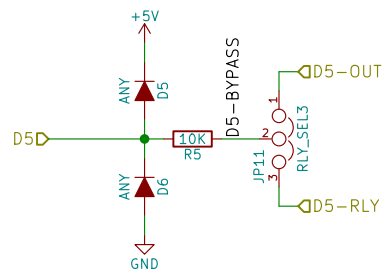
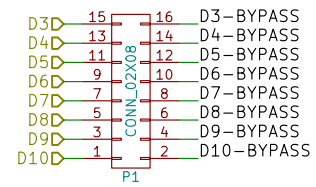
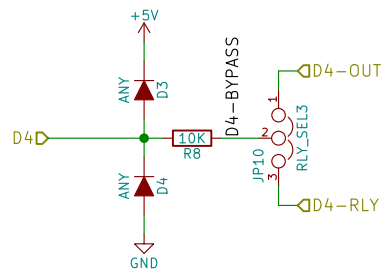
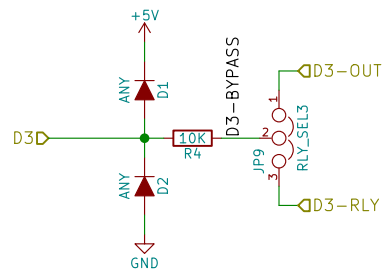

Sheet: /mode_selection/ File: mode_selection.sch	
<b>Title:</b>	
Size: A4	Date:
KiCad E.D.A. kicad 5.0.0	Rev: Id: 4/7

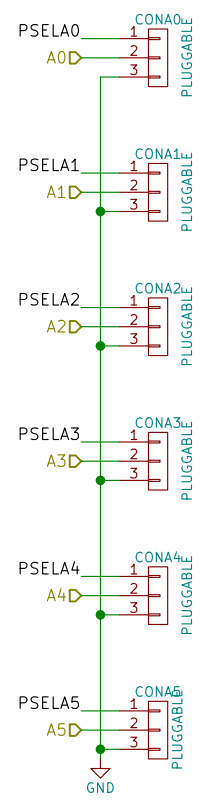
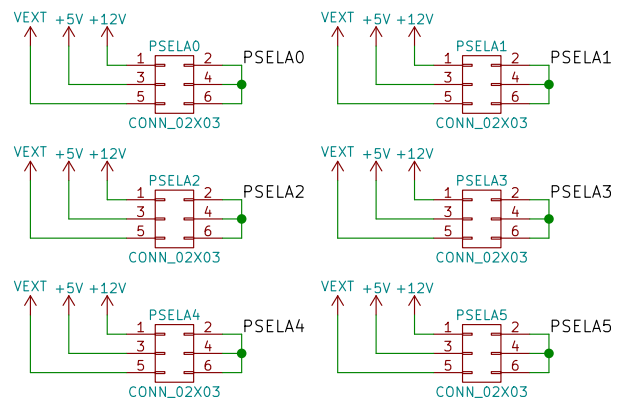

Sheet: /analog_io/		
File: analog_io.sch		
<b>Title:</b>		
Size: A4	Date:	Rev:
KiCad E.D.A. kicad 5.0.0		Id: 5/7

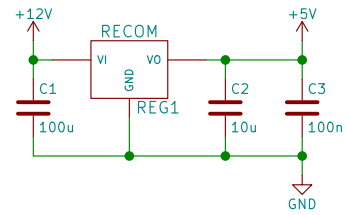
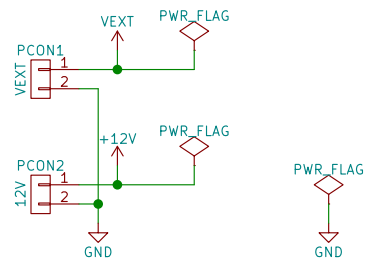

Sheet: /power/		Date:	
File: power.sch		Rev:	
<b>Title:</b>		Id: 6/7	
Size: A4	KiCad E.D.A. kicad 5.0.0		

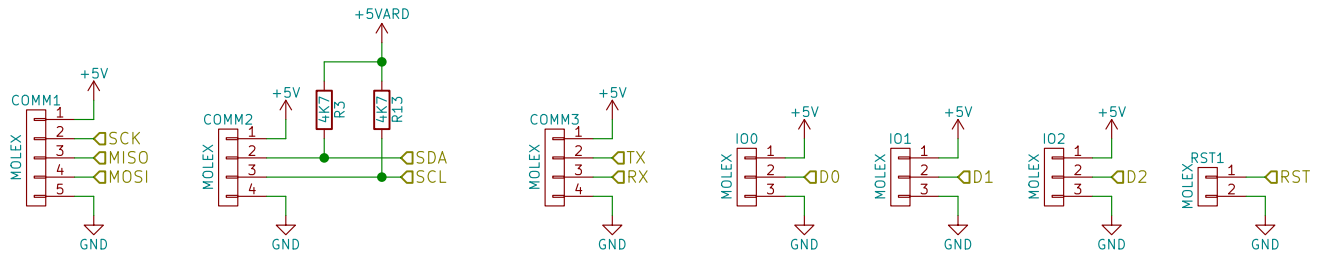

Sheet: /misc\_io/  
 File: misc\_io.sch

**Title:**

Size: A4

Date:

KiCad E.D.A. kicad 5.0.0

**Rev:**

Id: 7/7