

Sheet: /nano/
File: nano.sch

Title:

Size: A4
KiCad E.D.A. kicad 5.0.0

Date:

Rev:
Id: 2/7

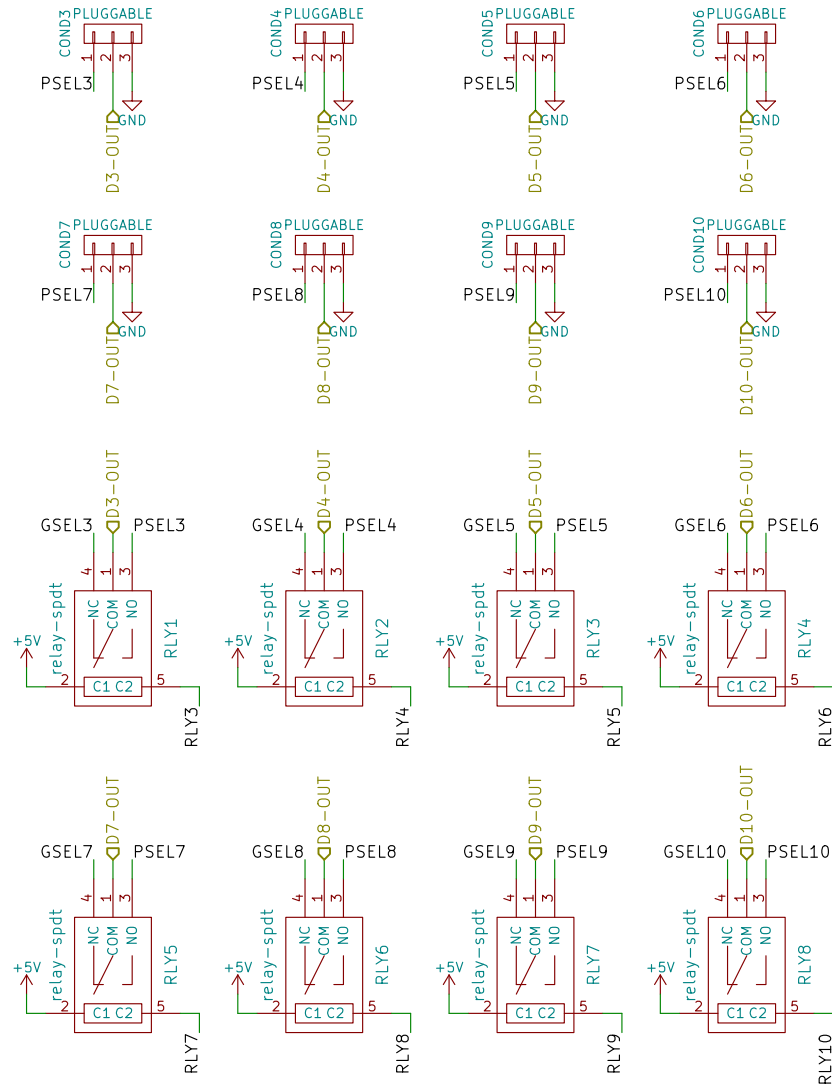
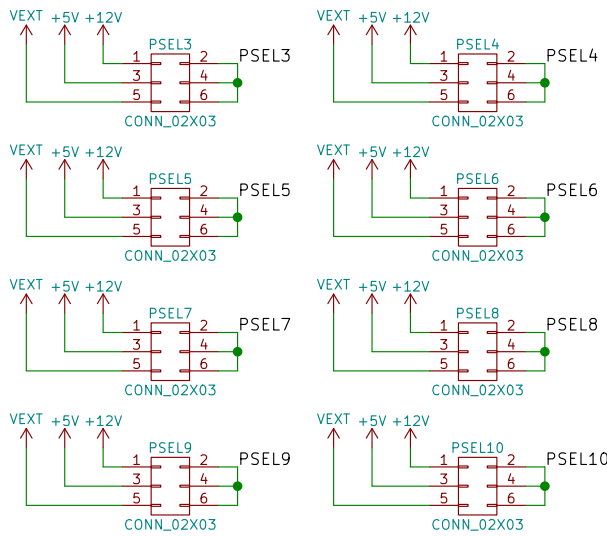
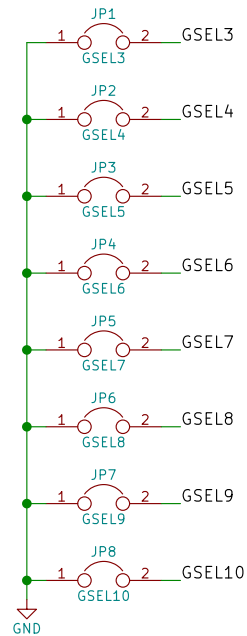
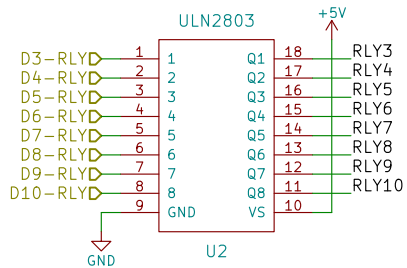

Sheet: /digital_io/
 File: digital_io.sch

Title:

Size: A4
 KiCad E.D.A. kicad 5.0.0

Date:

Rev:

Id: 3/7

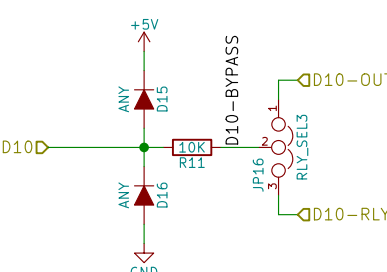
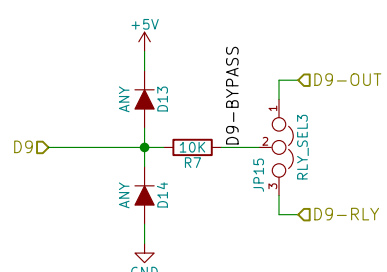
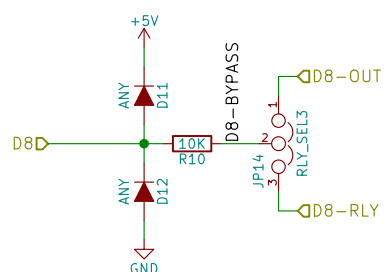
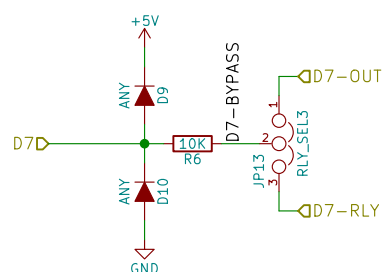
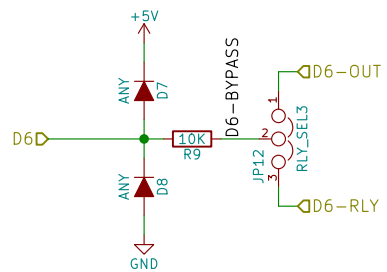
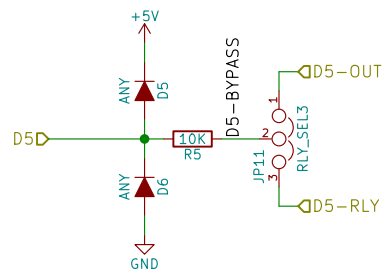
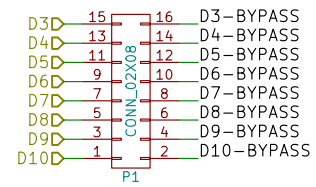
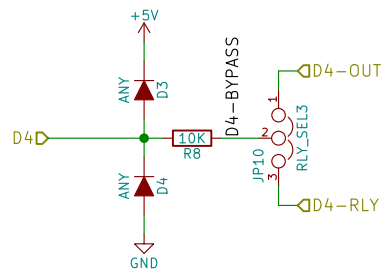
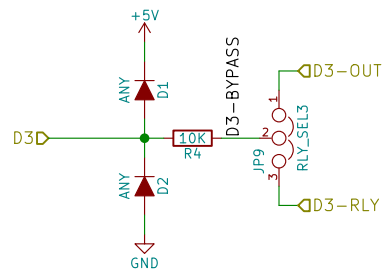

Sheet: /mode_selection/ File: mode_selection.sch	
Title:	
Size: A4	Date:
KiCad E.D.A. kicad 5.0.0	Rev: Id: 4/7

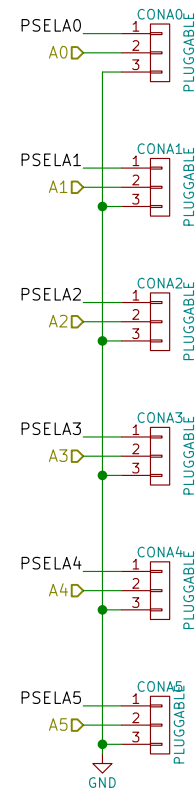
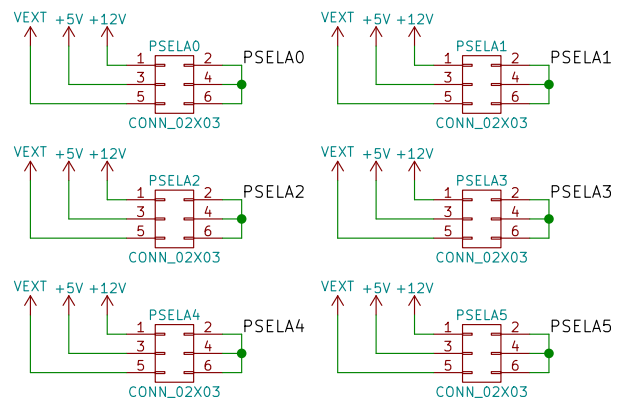

Sheet: /analog_io/
File: analog_io.sch

Title:

Size: A4

Date:

KiCad E.D.A. kicad 5.0.0

Rev:

Id: 5/7

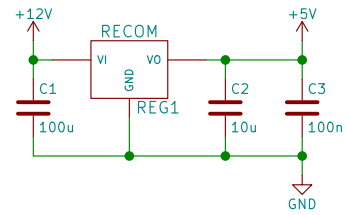
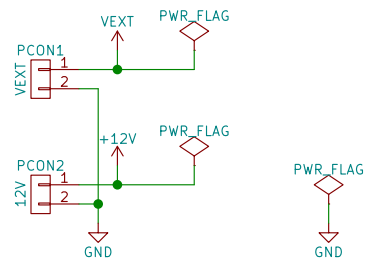

Sheet: /power/		Date:	
File: power.sch		Rev:	
Title:			
Size: A4	KiCad E.D.A. kicad 5.0.0	Id: 6/7	

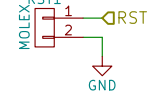
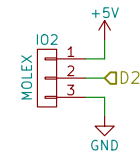
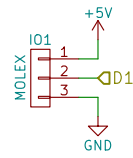
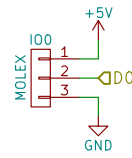
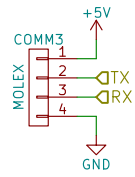
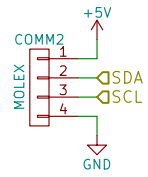
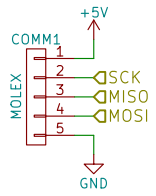

Sheet: /misc_io/
File: misc_io.sch

Title:

Size: A4

Date:

KiCad E.D.A. kicad 5.0.0

Rev:

Id: 7/7